

With an innovative design, these easy to install LED Display Clocks, viewable up to 200 feet away offer a high level of performance, quality, and reliability. The perfect solution for satisfying Digital Clock needs in all types of facilities.



Features:

- Highly Visible LED Display
- AM/PM Indicator
- Alternating Time and Date (self adjustable)
- 12/24 hr. Display Format
- Adjustable Brightness (dimming)
- 240/24 VAC
- Automatically Adjusts for DST
- Maintenance Free

Clock Styles

4" (10.16cm) 4 Digit White LED



2.5" (6.35cm) 6 Digit Red LED



4" (10.16cm) 4 Digit White LED



Digital Display Dual Ceiling Mount

2.5" (6.35cm) 4 Digit Red LED, 240 VAC **Part # 632417**
 2.5" (6.35cm) 4 Digit Red LED, 24 VAC **Part # 631417**
 2.5" (6.35cm) 4 Digit White LED, 240 VAC **Part # 632412**
 2.5" (6.35cm) 4 Digit White LED, 24 VAC **Part # 631412**
 2.5" (6.35cm) 6 Digit Red LED, 240 VAC **Part # 632317**
 2.5" (6.35cm) 6 Digit Red LED, 24 VAC **Part # 631317**

2.5" (6.35cm) 6 Digit White LED, 240 VAC **Part # 632312**
 2.5" (6.35cm) 6 Digit White LED, 24 VAC **Part # 631312**
 4" (10.16cm) 4 Digit Red LED, 240 VAC **Part # 642317**
 4" (10.16cm) 4 Digit Red LED, 24 VAC **Part # 641317**
 4" (10.16cm) 4 Digit White LED, 240 VAC **Part # 642312**
 4" (10.16cm) 4 Digit White LED, 24 VAC **Part # 641312**

2.5" (6.35cm) 6 Digit Red LED



4" 4 Digit White LED



2.5" 6 Digit Red LED

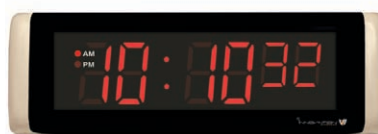

Digital Display Single Sided

2.5" (6.35cm) 4 Digit Red LED, 240 VAC **Part # 632407**
 2.5" (6.35cm) 4 Digit Red LED, 24 VAC **Part # 631407**
 2.5" (6.35cm) 4 Digit White LED, 240 VAC **Part # 632402**
 2.5" (6.35cm) 4 Digit White LED, 24 VAC **Part # 631402**
 2.5" (6.35cm) 6 Digit Red LED, 240 VAC **Part # 632307**
 2.5" (6.35cm) 6 Digit Red LED, 24 VAC **Part # 631307**

2.5" (6.35cm) 6 Digit White LED, 240 VAC **Part # 632302**
 2.5" (6.35cm) 6 Digit White LED, 24 VAC **Part # 631302**
 4" (10.16cm) 4 Digit Red LED, 240 VAC **Part # 642307**
 4" (10.16cm) 4 Digit Red LED, 24 VAC **Part # 641307**
 4" (10.16cm) 4 Digit White LED, 240 VAC **Part # 642302**
 4" (10.16cm) 4 Digit White LED, 24 VAC **Part # 641302**

Digital Display Dual Sided Wall Mount

2.5" (6.35cm) 4 Digit Red LED, 240 VAC **Part # 632427**
 2.5" (6.35cm) 4 Digit Red LED, 24 VAC **Part # 631427**
 2.5" (6.35cm) 4 Digit White LED, 240 VAC **Part # 632422**
 2.5" (6.35cm) 4 Digit White LED, 24 VAC **Part # 631422**
 2.5" (6.35cm) 6 Digit Red LED, 240 VAC **Part # 632327**
 2.5" (6.35cm) 6 Digit Red LED, 24 VAC **Part # 631327**
 2.5" (6.35cm) 6 Digit White LED, 240 VAC **Part # 632322**
 2.5" (6.35cm) 6 Digit White LED, 24 VAC **Part # 631322**
 4" (10.16cm) 4 Digit Red LED, 240 VAC **Part # 642327**
 4" (10.16cm) 4 Digit Red LED, 24 VAC **Part # 641327**
 4" (10.16cm) 4 Digit White LED, 240 VAC **Part # 642322**
 4" (10.16cm) 4 Digit White LED, 24 VAC **Part # 641322**

Digital Display Clock Specifications

2.5" (6.35cm) 4 and 6 Digit LED Display

- Sleek, Contoured Style
- Highly Visible LED Display
- Alternating Time and Date (self adjustable)
- 12/24 hr. Display Format
- Adjustable Brightness (dimming)
- 240 VAC or 24 VAC w/ 6 foot AC Adaptor
- Operating Temperature Range: 32°–122° F/–10° C – 50° C
- Storage Temperature Range: 14°–140° F/–10° C – 60° C
- Max Current Draw at 240V: 100mA

Side Mount - Front View

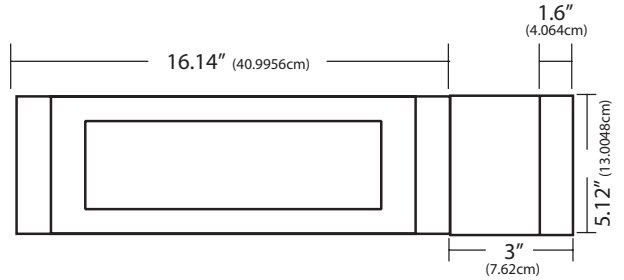
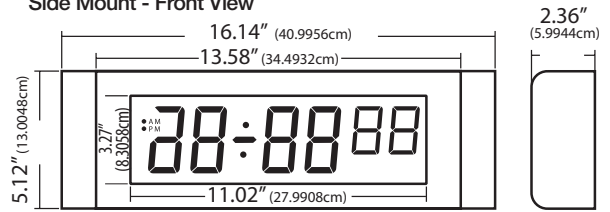

Ceiling Mount - Front View

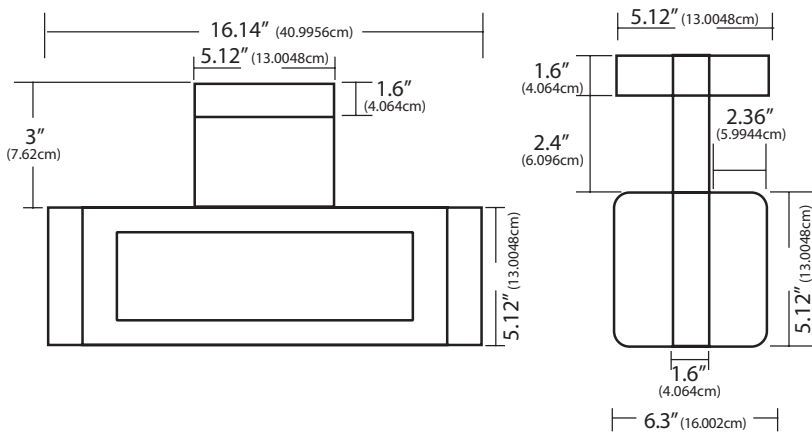

Back View

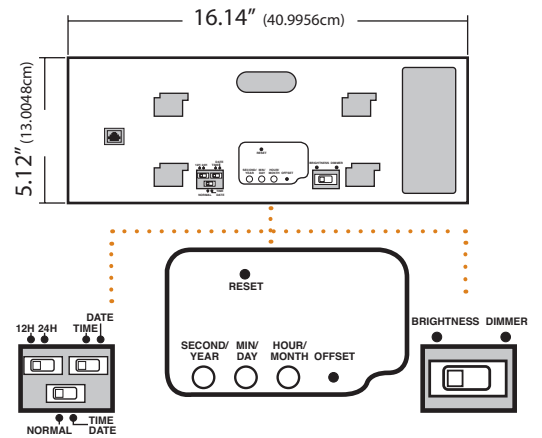

4" (10.16cm) 4 Digit LED Display

Side Mount - Front View

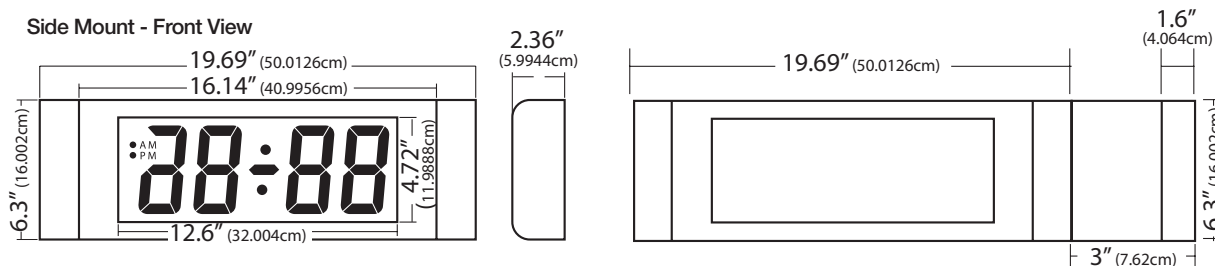

Ceiling Mount - Front View

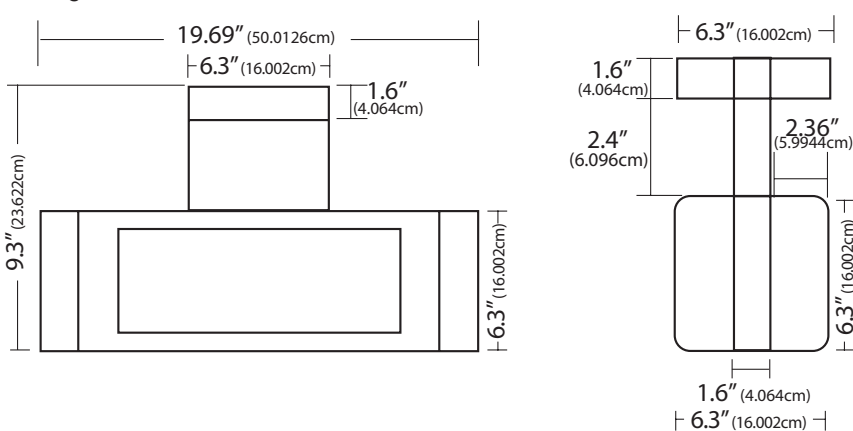

Back View

